



Series 6500
PERMA-PAX® Packed Expansion Joints

Catalog 986E

Series 6500 PERMA-PAX® Packed Expansion Joints

- Standard designs sizes 2" through 24", 150 & 300 PSIG at 500°F
- Axial travel of 4", 8" & 12" for single configurations, 8", 16" & 24" for dual anchor base configurations
- Minimum friction force. All expansion joints are factory cycled, and the friction force measured for conformance to specifications
- Carbon fiber graphite impregnated braided packing combined Grafoil® Flexible Graphite injected packing
- Line bored abrasion free aluminum bronze internal & external guides
- Self lubricating maintenance free
- Can be repacked under full system pressure



Hyspan Perma-Pax Packed Expansion Joints are a premium quality product with standard features that are not available or that are only offered as options for comparable products. The body is made from one piece, therefore eliminating a circumferential weld in the outer diameter. Internal and external guides are made from aluminum bronze bearing material that is welded in place and line bored for alignment and a precision fit to the traveling pipe. The sealing system consists of carbon fiber yarn impregnated with graphite and injected Grafoil® Flexible Graphite that has been optimized to minimize friction. These sealing materials remain flexible throughout the service life of the expansion joint, and have the added benefit of providing lubrication to the traveling pipe.

These design features combined with the Hyspan quality system that includes welding to ASME Code Section IX, and hydrostatic testing and cycling of all Perma-Pax expansion

joints, assure the user of a quality extended life product. Design conforms to ASTM F 1007 and Mil-E-17814.

Hyspan designs and manufactures Series 6500 expansion joints for custom applications including elevated pressure and temperature service, special materials and diameters greater than 24".

Since 1986 Hyspan has offered a full five year replacement warranty on standard design Series 6500 expansion joints—see Page 15 for details.

Grafoil is a UCAR registered trademark

Table of Contents

Design Features	3	Ordering Instructions	9
Applications	4	Table 5 Type 6501 & 6502 150 psig Design Data	10
Table 1 Intermediate Pipe Guide Spacing	5	Table 6 Type 6505 & 6506 150 psig Design Data	11
Travel Required	5	Table 7 Type 6501 & 6502 300 psig Design Data	12
Anchor Forces	6	Table 8 Type 6505 & 6506 300 psig Design Data	13
Table 2 Thermal Expansion	7	Installation Procedure & Maintenance Instructions	14
Table 3 Pressure Thrust & Seal Force Data	7	Table 9 Installation Preset	15
Materials of Construction	8	Five Year Limited Warranty	15
Table 4 Dimensional Data	8		

Design Features

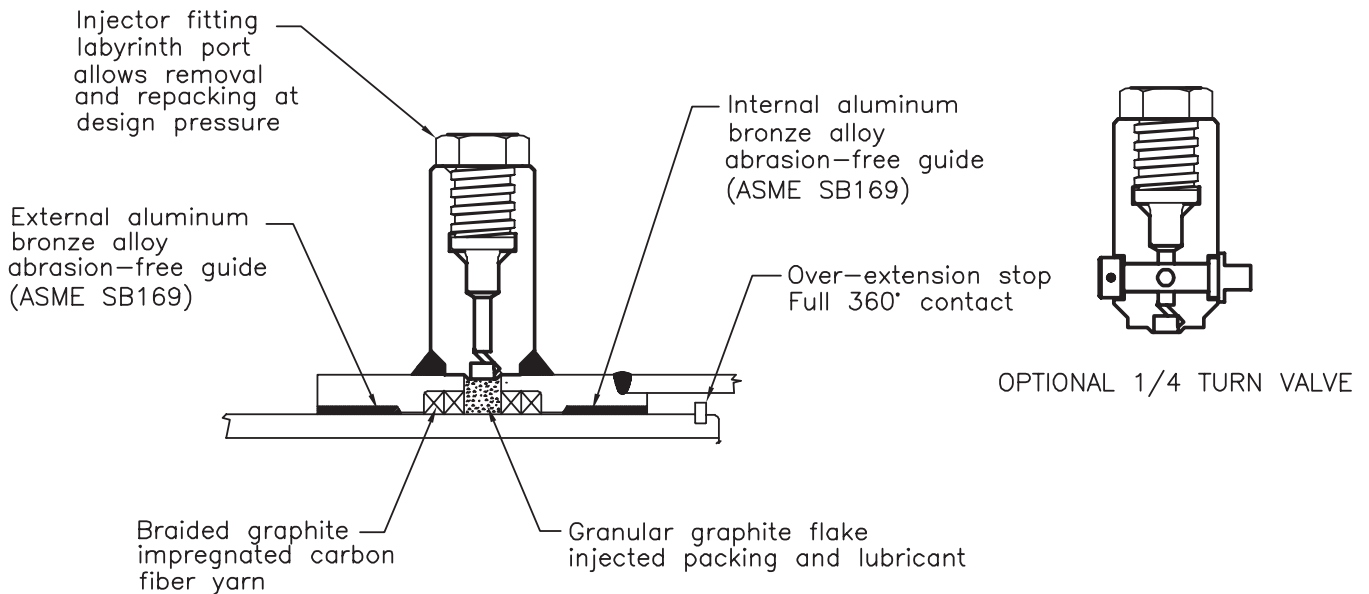
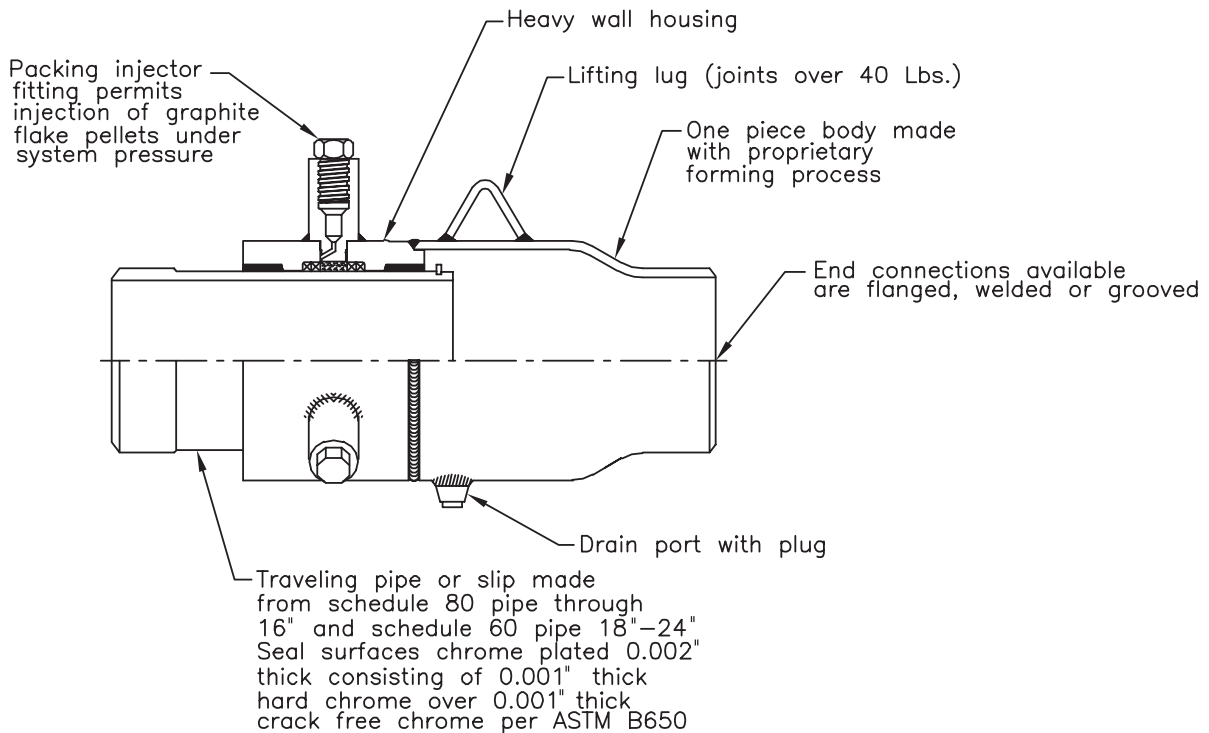

Single Expansion Joint, 6501 or 6502 Adjacent to Main Anchor

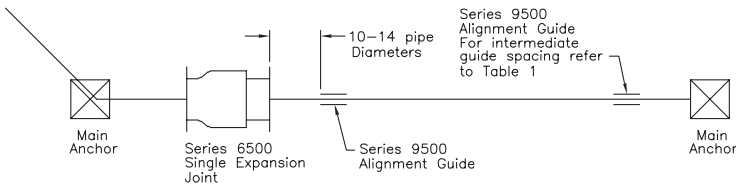

Single Expansion Joint 6501 or 6502 Located in the Middle of a Run

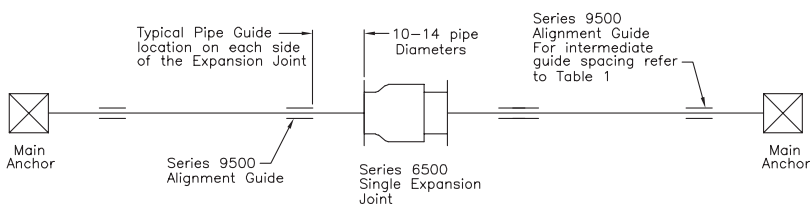

Two or More Single Expansion Joints, 6501 or 6502 with Intermediate Anchors

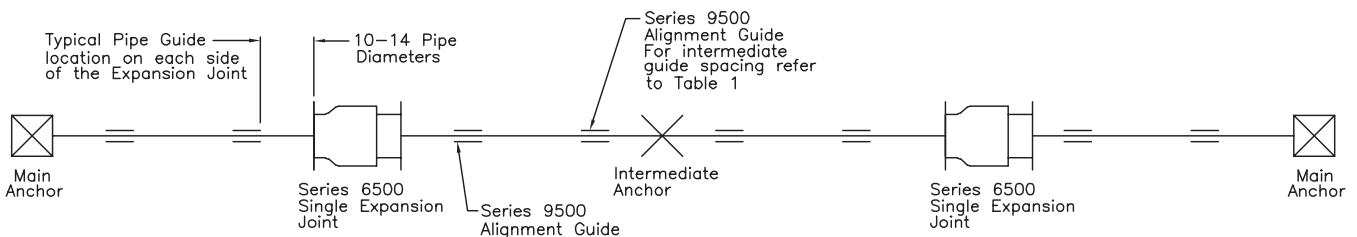

Dual Anchor Base Expansion Joint, 6505 or 6506 Located in the Center of a Run

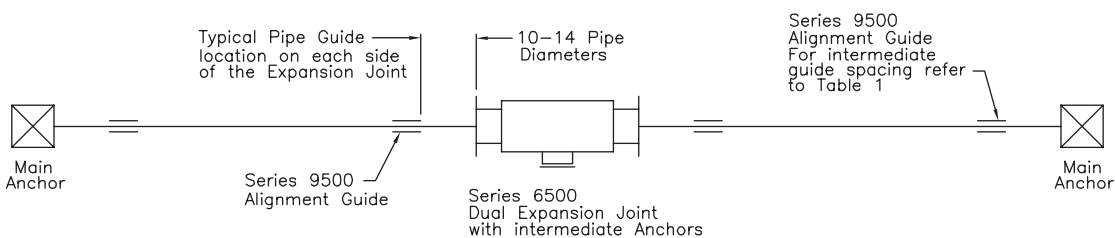

Applications

Series 6500 expansion joints are designed for installations where the principal movement is axial. Standard single configurations are designed for 4", 8" and 12" of axial compression (pipe expansion) and 1", 1.5" and 2" extension respectively. Dual configurations are designed for 8", 16" and 24" of axial compression and 2", 3" and 4" extension respectively. If the primary movement is extension (pipe contraction), the expansion joint can be preset at the factory. The piping system must include anchors to react the force produced by pressure thrust and the friction force, supports to react the weight of the pipe and media, and guides to ensure that the pipe alignment is maintained.

Table 1 Intermediate Pipe Guide Spacing/Series 6500 Packed Expansion Joints

Nominal Size (NPS)	First Guide Spacing (feet)(1)	Intermediate Guide Spacing (feet)(2)					Support Spacing(3)	
		100 psig	150 psig	200 psig	300 psig	400 psig	Water (feet)	Gas (feet)
2	2	12	11	11	10	9	10	13
2 1/2	2 1/2	16	15	14	13	12	11	14
3	3	20	18	17	15	14	12	15
4	4	25	23	21	19	17	14	17
5	5	31	28	26	23	20	16	18
6	6	37	34	31	27	24	17	21
8	8	49	43	39	34	30	19	24
10	10	61	53	48	41	36	22	27
12	12	70	61	54	46	41	23	30
14	14	74	64	57	49	43	25	32
16	16	81	70	62	53	46	27	35
18	18	88	75	67	56	50	28	37
20	20	94	80	71	60	53	30	39
24	24	105	90	79	66	58	32	42
1	2	3	4	5	6	7	8	9

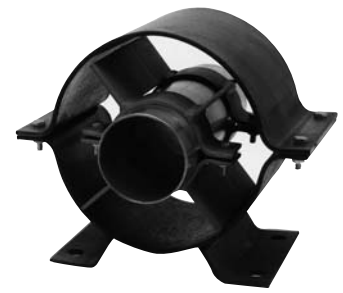

Series 9500 Pipe Alignment Guide

Note:

- (1) Distance measured is from the face of the expansion joint. Recommend distance 10–14 pipe diameters. Tabulated values are based on 12 pipe diameters.
- (2) Tabulated values are based on Hyspan Series 6500 friction forces and standard weight carbon steel pipe. Distances are center to center. Pressures are design values. Guide spacing has been calculated for test pressure (1.5 X design.)
- (3) Tabulated values are the maximum recommended—source ASME 31.1 Power Piping Code.

Travel Required

The axial expansion or contraction of pipe is determined by the change in temperature. In order to select the correct travel refer to Table 2 which includes tabulated values of linear change in inches per 100 feet of pipe run for steel and stainless steel pipe. The values are based on an installation temperature of 70°F.

$$\text{Thermal Expansion or contraction (inches)} = \frac{\text{Length of run between anchors (feet)}}{100} \times \text{Linear change from Table 2}$$

During installation if the temperature is substantially different from 70°F it may be necessary to preset the expansion joint. Refer to Installation Preset, Table 9, on Page 15 to determine the preset required.

Anchors

Piping systems incorporating Type 6501–6506 expansion joints must include structural reactions or main anchors as shown in the application diagrams on Page 4 that are designed to react the full pressure thrust force based on the effective area of the expansion joint, and the joint seal resistance force.

$$\begin{array}{l} \text{Main Anchor} \\ \text{Force (lbs.)} \end{array} = \begin{array}{l} \text{Pressure Force} \\ \text{Table 3 (lbs)} \end{array} + \begin{array}{l} \text{Joint Seal Resistance Force} \\ \text{Column 3 Table 3 (lbs)} \end{array}$$

The pressure thrust force must be based on the highest pressure anticipated during service and testing.

The joint seal force values tabulated in Column 3 of Table 3 are the highest anticipated—at “break away”. These values are reduced by approximately 25% after motion starts.

Piping systems incorporating dual anchor base expansion joints (6505 & 6506) or multiple single joints (6501 & 6502) in long runs must include structural reactions or intermediate anchors as shown in the application diagrams on Page 4. Intermediate anchors react the seal resistance force—the purpose of the intermediate anchor is to ensure that the pipe expansion in each segment of the run is absorbed by the expansion joint in that segment.

$$\begin{array}{l} \text{Intermediate} \\ \text{Anchor Force (lbs)} \end{array} = \begin{array}{l} \text{Joint Seal Resistance Force} \\ \text{Column 3 Table 3 (lbs)} \end{array}$$

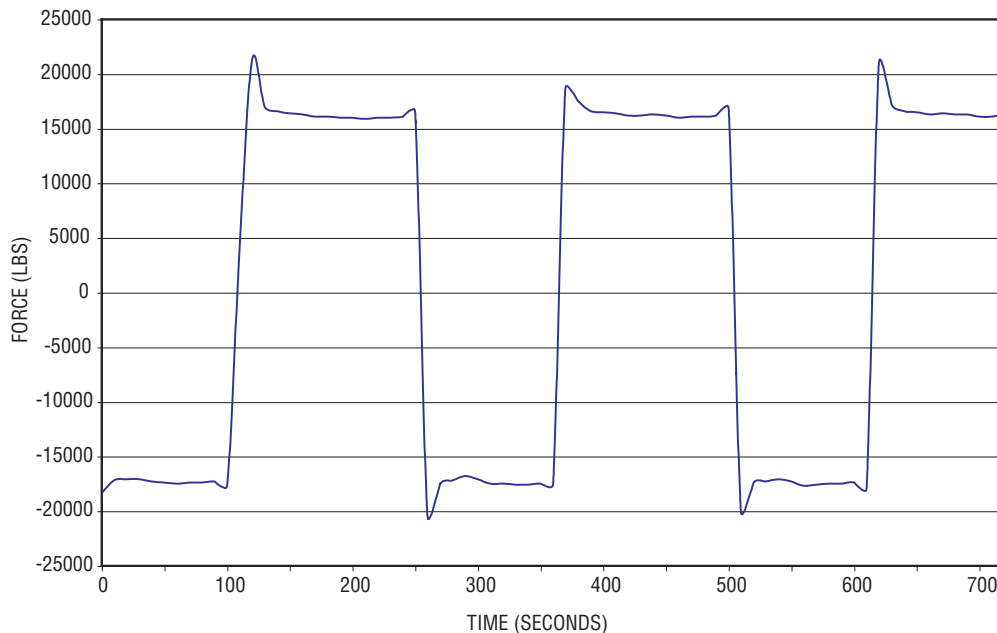

Each Series 6500 expansion joint is cycled a minimum of ten complete cycles with the force continuously measured by a load cell with the measurements analyzed by a computer program. The program determines if the force exceeds specifications at any point during the cycling. The illustration shows a profile of each cycle as the joint is compressed to the design travel (4", 8" or 12") and extended to the manufactured length. The “peaks” illustrate the breakaway force which is reduced as the travel progresses.

Table 2 Thermal Expansion of Pipe per 100 feet

Linear thermal expansion of pipe per 100 feet between 70°F and the tabulated temperature.

The tabulated values in Columns 5 and 6 are measured in inches per 100 feet of pipe run.

Saturated Steam		Temperature		Carbon Steel Pipe	Austenitic Stainless Steel
Vacuum (Hg)	Pressure (psig)	°F	°C		
		-50	-46	-0.84	-1.24
		0	-18	-0.49	-0.72
		25	-4	-0.32	-0.46
29.7		32	0	-0.27	-0.40
29.6		50	10	-0.14	-0.21
29.2		70	21	0	0
28.0		100	38	0.23	0.34
26.0		125	52	0.42	0.62
22.4		150	66	0.61	0.90
16.3		175	80	0.80	1.18
6.0		200	93	0.99	1.46
0		212	100	1.10	1.60
	4	225	107	1.21	1.75
	5	250	121	1.40	2.03
	31	275	135	1.61	2.32
	52	300	149	1.82	2.61
	82	325	163	2.04	2.90
	120	350	177	2.26	3.20
	169	375	191	2.48	3.50
	232	400	205	2.70	3.80
	311	425	219	2.93	4.10
	407	450	232	3.16	4.41
	525	475	246	3.39	4.71
	664	500	260	3.62	5.01
1	2	3	4	5	6

Table 3 Pressure Thrust and Seal Force Data/Series 6500 Packed Expansion Joints

Nominal Size (NPS)	Effective Area (square inches)	Joint Seal Force (lbs)	Tabulated Force (pounds) for Individual Pressure					
			50 psig	100 psig	150 psig	225 psig	300 psig	450 psig
2	4.0	1700	199	398	596	895	1193	1789
2 1/2	5.9	2125	297	594	891	1337	1782	2673
3	8.9	2550	447	895	1342	2013	2684	4026
4	15.0	3400	752	1503	2255	3382	4510	6765
5	23.2	4250	1161	2322	3483	5225	6966	10449
6	32.5	5100	1627	3255	4882	7323	9764	14647
8	55.9	6800	2796	5591	8387	12581	16774	25161
10	86.6	8500	4330	8659	12989	19483	25977	38966
12	123.0	10,200	6136	12272	18480	27612	36816	55224
14	148.0	11,900	7424	14849	22274	33410	44547	66821
16	195.0	13,600	9742	19483	29225	43837	58449	87674
18	247.0	15,300	12373	24745	37118	55676	74235	111353
20	306.0	17,000	15318	30636	45954	68931	91908	137862
24	443.0	20,400	22151	44301	66452	99677	132903	199355
1	2	3	4	5	6	7	8	9

The Seal Force, Column 3, is the maximum value allowed. Each joint is cycled and the value measured for quality assurance.

Materials of Construction and Dimensional Data

The following materials, processes and specifications are used for the construction of all standard Series 6500 expansion Joints.

Slip (Traveling Pipe): Schedule 80 ASME A53 Gr. B pipe through 16" diameter, Schedule 60 ASME A53 Gr. B pipe 18" through 24" diameter. The seal surface is precision machined and coated to a total thickness of 0.002" thick consisting of a 0.001" thick layer of crack free chrome over a 0.001" thick layer of industrial hard chrome in accordance with ASTM B 650.

Over Travel Stop Ring: ASTM A240 austenitic stainless steel.

Body: One piece construction formed by a Hyspan proprietary process made from ASME A53 Gr. B pipe. Schedule is standard weight unless otherwise specified.

Drain Port and Plug: 3000 lb. thread-o-let made from ASME A105 steel forging.

Seal Housing: C1018 steel or ASME A53 Gr. B heavy wall pipe.

Injector Fitting Body: C1018 steel. Optional Injectors with 1/4 turn safety valves include an austenitic stainless steel valve stem.

Injector Fitting Plunger: AISI 1144 high strength steel.

Internal and External Guides: ASME SB169 aluminum bronze abrasion free alloy.

Braided Packing: Braided graphite impregnated carbon fiber yarn.

Injected Packing: Graphite flakes with synthetic oil carrier, Grafoil® Flexible Graphite.

Flanges: ASME/ANSI B16.5 150 lb. or 300 lb. raised face slip-on ASME A105 forged steel.

Weld End Preparation: ASME/ANSI B16.9 beveled 37.5° for standard weight pipe unless otherwise specified.

Grooved End Preparation: ASME/AWWA C606-87.

Anchor Base: ASME A36 steel plate.

Grafoil is a UCAR registered trademark.



Additional packing is available in kits of 13 pellets for maintenance of installed expansion joints.

Table 4 Dimensional Data

Nominal Size (NPS)	Body Outside Diameter (inches)	Radial Clearance Required (inches)	Number of Packing Fittings	Centerline Height (inches) 6501AB 6502AB 6505 6506	Drain Port Size (NPS)	Anchor Base Pattern 6501AB, 6502AB, 6505, 6506				
						Hole Diameter (inches)	Base Length (L) (inches)	Base Width (W) (inches)	Hole Spacing (inches)	
									A	B
2	3.50	8.88	2	3.88	1/2	0.625	6.0	7.0	5.0	4.0
2 1/2	4.00	9.00	2	4.88	1/2	0.625	6.0	7.0	5.0	4.0
3	4.50	9.31	2	4.88	1/2	0.625	6.0	7.5	5.5	4.0
4	5.56	9.88	2	5.50	1/2	0.625	6.0	9.5	7.5	4.0
5	6.63	10.38	3	6.50	1/2	0.875	6.0	9.5	7.5	4.0
6	8.63	11.38	3	6.50	3/4	0.875	8.0	12.0	10.0	6.0
8	10.75	12.50	4	9.25	3/4	1.125	9.0	13.0	10.0	6.0
10	12.75	13.50	4	9.75	3/4	1.125	11.0	17.0	14.0	8.0
12	14.00	14.00	5	12.00	3/4	1.375	12.0	20.0	16.0	8.0
14	16.00	15.00	5	15.50	3/4	1.375	12.0	22.0	18.0	8.0
16	18.00	16.00	6	15.50	1	1.375	14.0	22.0	18.0	10.0
18	20.00	17.00	6	16.25	1	1.375	14.0	22.0	18.0	10.0
20	22.00	18.00	8	18.00	1	1.625	19.0	27.0	22.0	14.0
24	26.25	20.18	8	20.00	1	1.625	19.0	27.0	22.0	14.0
1	2	3	4	5	6	7	8	9	10	11

Note: Add 1.25" to the values in Column 3 for injectors with optional 1/4 turn valves.

Type 6501 & 6502 expansion joints are available with full thrust anchor bases.

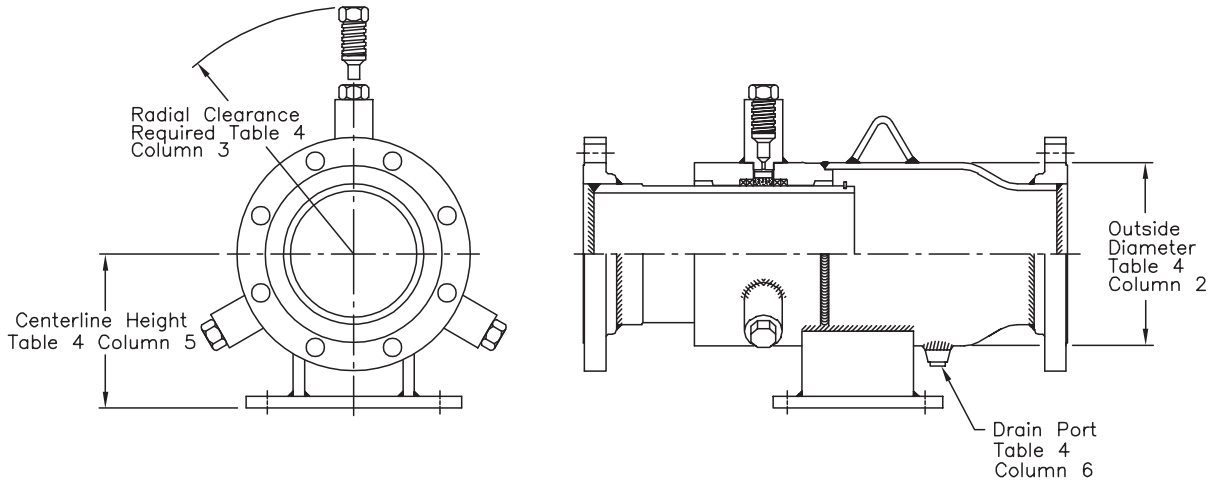

Anchor Base drilling dimensions. Refer to Columns 7–11 of Table 4 for details.

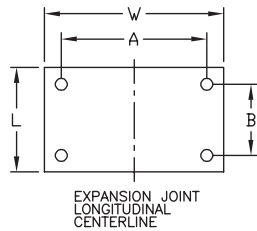

Injector Fitting orientation

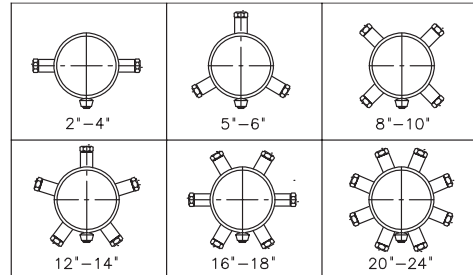

Ordering Instructions

Refer to Tables 5 through 8 to select the configuration and service conditions required for your application. If the travel required is unknown see the method of calculation on Page 5.

Example

2" NPS
Single Expansion Joint
Steel pipe weld ends
150 psig at 500°F maximum
4.0" axial travel maximum

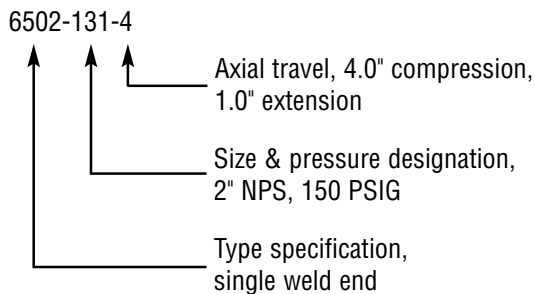

Single expansion joints, 6501 and 6502, ordered with anchor based are identified as 6501AB and 6502AB. Anchor bases are standard on dual anchor base joints, 6505 and 6506, and do not require the AB suffix.

Optional features must be specified by a written description accompanying the part number. Options that are available include:

- Higher rated pressure and temperature
- Vent or instrumentation ports
- Service outlets (size and orientation must be specified)
- 1/4 Turn valve on each injector fitting
- Alternate materials
- Factory preset of overall length
- Grooved end attachments
- Threaded adjusting rods for field preset

Table 5 Type 6501 and 6502

Design Pressure: 150 psig Test Pressure: 225 psig Design Temperature: 500° F

Nominal Size (NPS)	Part Number 6501 6502	Axial Comp. (inches)	Axial Ext. (inches)	6501 Fixed Flange		6502 Weld End	
				Overall Length (inches)	Weight (lbs)	Overall Length (inches)	Weight (lbs)
2	-131-4	4.0	1.0	19.75	27	19.25	17
	-131-8	8.0	1.5	28.75	31	28.25	21
	-131-12	12.0	2.0	37.75	34	37.25	24
2 1/2	-135-4	4.0	1.0	20.38	39	19.75	23
	-135-8	8.0	1.5	29.38	45	28.75	29
	-135-12	12.0	2.0	38.38	50	37.75	34
3	-140-4	4.0	1.0	21.75	48	21.00	30
	-140-8	8.0	1.5	30.75	55	30.00	37
	-140-12	12.0	2.0	39.75	61	39.00	43
4	-148-4	4.0	1.0	23.63	70	22.88	44
	-148-8	8.0	1.5	32.63	80	31.88	54
	-148-12	12.0	2.0	41.63	89	40.88	63
5	-155-4	4.0	1.0	25.25	94	24.25	64
	-155-8	8.0	1.5	34.25	107	33.25	77
	-155-12	12.0	2.0	43.25	120	42.25	90
6	-160-4	4.0	1.0	25.75	140	24.75	106
	-160-8	8.0	1.5	34.75	157	33.75	123
	-160-12	12.0	2.0	43.75	174	42.75	140
8	-167-4	4.0	1.0	27.63	238	26.38	182
	-167-8	8.0	1.5	36.63	265	35.38	209
	-167-12	12.0	2.0	45.63	293	44.38	237
10	-174-4	4.0	1.0	28.38	319	27.13	239
	-174-8	8.0	1.5	37.38	359	36.13	279
	-174-12	12.0	2.0	46.38	398	45.13	318
12	-180-4	4.0	1.0	30.00	419	28.50	297
	-180-8	8.0	1.5	39.00	470	37.50	348
	-180-12	12.0	2.0	48.00	520	46.50	398
14	-181-4	4.0	1.0	31.38	537	29.88	371
	-181-8	8.0	1.5	40.38	593	38.88	427
	-181-12	12.0	2.0	49.38	649	47.88	483
16	-182-4	4.0	1.0	32.38	622	30.88	410
	-182-8	8.0	1.5	41.38	681	39.88	469
	-182-12	12.0	2.0	50.38	740	48.88	528
18	-183-4	4.0	1.0	34.63	755	33.13	537
	-183-8	8.0	1.5	43.63	828	42.13	610
	-183-12	12.0	2.0	52.63	900	51.13	682
20	-184-4	4.0	1.0	35.88	951	34.13	655
	-184-8	8.0	1.5	44.88	1037	43.13	741
	-184-12	12.0	2.0	53.88	1125	52.13	829
24	-186-4	4.0	1.0	37.13	1420	35.13	1012
	-186-8	8.0	1.5	46.13	1555	44.13	1147
	-186-12	12.0	2.0	55.13	1692	53.13	1284
1	2	3	4	5	6	7	8

6501 Fixed Flange

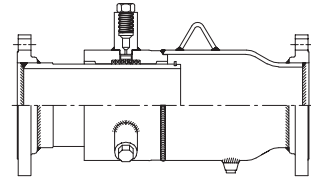

6502 Weld End

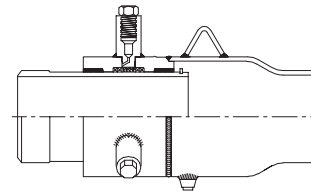
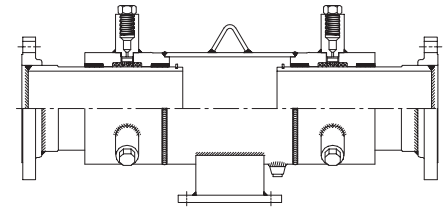

Table 6 Type 6505 and 6506

Design Pressure: 150 psig Test Pressure: 225 psig Design Temperature: 500° F

Nominal Size (NPS)	Part Number 6505 6506	Total Axial Compression (inches)	Total Axial Extension (inches)	6505 Fixed Flange Center Anchor Base		6506 Weld End Center Anchor Base	
				Overall Length (inches)	Weight (lbs)	Overall Length (inches)	Weight (lbs)
2	-131-8	8.0	2.0	33.00	49	32.50	39
	-131-16	16.0	3.0	51.00	59	50.50	49
	-131-24	24.0	4.0	69.00	68	68.50	58
2 1/2	-135-8	8.0	2.0	33.38	65	32.75	49
	-135-16	16.0	3.0	51.38	77	50.75	61
	-135-24	24.0	4.0	69.38	89	68.75	73
3	-140-8	8.0	2.0	35.25	78	34.50	60
	-140-16	16.0	3.0	53.25	94	52.50	76
	-140-24	24.0	4.0	71.25	109	70.50	91
4	-148-8	8.0	2.0	38.25	115	37.50	89
	-148-16	16.0	3.0	56.25	137	55.50	111
	-148-24	24.0	4.0	74.25	158	73.50	132
5	-155-8	8.0	2.0	41.00	153	40.00	123
	-155-16	16.0	3.0	59.00	183	58.00	153
	-155-24	24.0	4.0	77.00	213	76.00	183
6	-160-8	8.0	2.0	43.00	250	42.00	216
	-160-16	16.0	3.0	61.00	288	60.00	254
	-160-24	24.0	4.0	79.00	326	78.00	292
8	-167-8	8.0	2.0	46.00	419	44.75	363
	-167-16	16.0	3.0	64.00	482	62.75	426
	-167-24	24.0	4.0	82.00	545	80.75	489
10	-174-8	8.0	2.0	47.00	567	45.75	487
	-174-16	16.0	3.0	65.00	656	63.75	576
	-174-24	24.0	4.0	83.00	745	81.75	665
12	-180-8	8.0	2.0	48.00	725	46.50	603
	-180-16	16.0	3.0	66.00	839	64.50	717
	-180-24	24.0	4.0	84.00	953	82.50	831
14	-181-8	8.0	2.0	50.50	840	49.00	674
	-181-16	16.0	3.0	68.50	966	67.00	800
	-181-24	24.0	4.0	86.50	1092	85.00	926
16	-182-8	8.0	2.0	51.75	987	50.25	775
	-182-16	16.0	3.0	69.75	1121	68.25	909
	-182-24	24.0	4.0	87.75	1254	86.25	1042
18	-183-8	8.0	2.0	55.50	1243	54.00	1025
	-183-16	16.0	3.0	73.50	1406	72.00	1188
	-183-24	24.0	4.0	91.50	1568	90.00	1350
20	-184-8	8.0	2.0	57.00	1928	55.25	1632
	-184-16	16.0	3.0	75.00	2201	73.25	1905
	-184-24	24.0	4.0	93.00	2473	91.25	2177
24	-186-8	8.0	2.0	60.00	2450	58.00	2042
	-186-16	16.0	3.0	78.00	2757	76.00	2349
	-186-24	24.0	4.0	96.00	3064	94.00	2656
1	2	3	4	5	6	7	8

6505 Fixed Flange Dual Anchor Base



6506 Weld End Dual Anchor Base

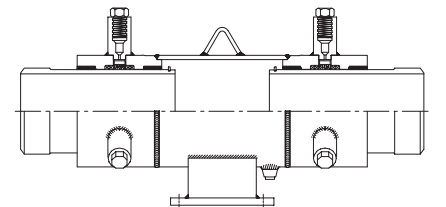

Note:

- (1) Refer to Table 3 for pressure thrust and friction force.
- (2) For Type 6505 and 6506 the travel stated is the total. Travel each side of the anchor base is 1/2 of the tabulated value.
- (3) Refer to Table 4 for the housing outside diameter, packer clearance, drain port size, centerline height for anchor base models, and anchor base details.

Table 7 Type 6501 and 6502

Design Pressure: 300 psig Test Pressure: 450 psig Design Temperature: 500° F

Nominal Size (NPS)	Part Number 6501 6502	Axial Comp. (inches)	Axial Ext. (inches)	6501 Fixed Flange		6502 Weld End	
				Overall Length (inches)	Weight (lbs)	Overall Length (inches)	Weight (lbs)
2	-331-4	4.0	1.0	19.75	31	19.25	17
	-331-8	8.0	1.5	28.75	35	28.25	21
	-331-12	12.0	2.0	37.75	38	37.25	24
2 1/2	-335-4	4.0	1.0	20.38	43	19.75	23
	-335-8	8.0	1.5	29.38	49	28.75	29
	-335-12	12.0	2.0	38.38	54	37.75	34
3	-340-4	4.0	1.0	21.75	56	21.00	30
	-340-8	8.0	1.5	30.75	63	30.00	37
	-340-12	12.0	2.0	39.75	69	39.00	43
4	-348-4	4.0	1.0	23.63	91	22.88	44
	-348-8	8.0	1.5	32.63	101	31.88	54
	-348-12	12.0	2.0	41.63	110	40.88	63
5	-355-4	4.0	1.0	25.25	122	24.25	64
	-355-8	8.0	1.5	34.25	135	33.25	77
	-355-12	12.0	2.0	43.25	148	42.25	90
6	-360-4	4.0	1.0	25.75	178	24.75	106
	-360-8	8.0	1.5	34.75	195	33.75	123
	-360-12	12.0	2.0	43.75	212	42.75	140
8	-367-4	4.0	1.0	27.63	294	26.38	182
	-367-8	8.0	1.5	36.63	321	35.38	201
	-367-12	12.0	2.0	45.63	349	44.38	237
10	-374-4	4.0	1.0	28.38	393	27.13	239
	-374-8	8.0	1.5	37.38	433	36.13	279
	-374-12	12.0	2.0	46.38	472	45.13	318
12	-380-4	4.0	1.0	30.00	523	28.50	297
	-380-8	8.0	1.5	39.00	574	37.50	348
	-380-12	12.0	2.0	48.00	624	46.50	398
14	-381-4	4.0	1.0	31.38	689	29.88	371
	-381-8	8.0	1.5	40.38	745	38.88	427
	-381-12	12.0	2.0	49.38	801	47.88	483
16	-382-4	4.0	1.0	32.38	830	30.88	410
	-382-8	8.0	1.5	41.38	889	39.88	469
	-382-12	12.0	2.0	50.38	948	48.88	528
18	-383-4	4.0	1.0	34.63	1043	33.13	537
	-383-8	8.0	1.5	43.63	1116	42.13	610
	-383-12	12.0	2.0	52.63	1188	51.13	682
20	-384-4	4.0	1.0	35.88	1269	34.13	655
	-384-8	8.0	1.5	44.88	1355	43.13	741
	-384-12	12.0	2.0	53.88	1443	52.13	829
24	-386-4	4.0	1.0	39.13	1691	35.13	1079
	-386-8	8.0	1.5	48.13	1826	44.13	1214
	-386-12	12.0	2.0	57.13	1963	53.13	1351
1	2	3	4	5	6	7	8

6501 Fixed Flange

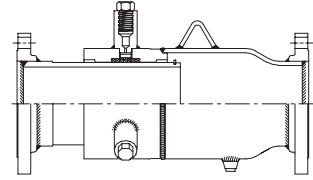

6502 Weld End

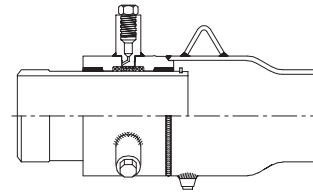
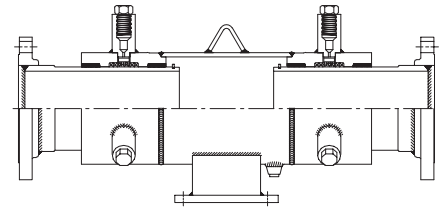

Table 8 Type 6505 and 6506

Design Pressure: 300 psig Test Pressure: 450 psig Design Temperature: 500° F

Nominal Size (NPS)	Part Number 6505 6506	Total Axial Compression (inches)	Total Axial Extension (inches)	6505 Fixed Flange Center Anchor Base		6506 Weld End Center Anchor Base	
				Overall Length (inches)	Weight (lbs)	Overall Length (inches)	Weight (lbs)
2	-331-8	8.0	2.0	33.00	53	32.50	39
	-331-16	16.0	3.0	51.00	63	50.50	49
	-331-24	24.0	4.0	69.00	72	68.50	58
2 1/2	-335-8	8.0	2.0	33.38	69	32.75	49
	-335-16	16.0	3.0	51.38	81	50.75	61
	-335-24	24.0	4.0	69.38	93	68.75	73
3	-340-8	8.0	2.0	35.25	86	34.50	60
	-340-16	16.0	3.0	53.25	102	52.50	76
	-340-24	24.0	4.0	71.25	117	70.50	91
4	-348-8	8.0	2.0	38.25	136	37.50	89
	-348-16	16.0	3.0	56.25	158	55.50	111
	-348-24	24.0	4.0	74.25	179	73.50	132
5	-355-8	8.0	2.0	41.00	181	40.00	123
	-355-16	16.0	3.0	59.00	211	58.00	153
	-355-24	24.0	4.0	77.00	241	76.00	183
6	-360-8	8.0	2.0	43.00	288	42.00	216
	-360-16	16.0	3.0	61.00	326	60.00	254
	-360-24	24.0	4.0	79.00	364	78.00	292
8	-367-8	8.0	2.0	46.00	475	44.75	363
	-367-16	16.0	3.0	64.00	538	62.75	426
	-367-24	24.0	4.0	82.00	601	80.75	489
10	-374-8	8.0	2.0	47.00	641	45.75	487
	-374-16	16.0	3.0	65.00	730	63.75	576
	-374-24	24.0	4.0	83.00	819	81.75	665
12	-380-8	8.0	2.0	48.00	829	46.50	603
	-380-16	16.0	3.0	66.00	943	64.50	717
	-380-24	24.0	4.0	84.00	1057	82.50	831
14	-381-8	8.0	2.0	50.50	992	49.00	674
	-381-16	16.0	3.0	68.50	1118	67.00	800
	-381-24	24.0	4.0	86.50	1244	85.00	926
16	-382-8	8.0	2.0	51.75	1195	50.25	775
	-382-16	16.0	3.0	69.75	1329	68.25	909
	-382-24	24.0	4.0	87.75	1462	86.25	1042
18	-383-8	8.0	2.0	55.50	1531	54.00	1025
	-383-16	16.0	3.0	73.50	1694	72.00	1188
	-383-24	24.0	4.0	91.50	1856	90.00	1350
20	-384-8	8.0	2.0	57.00	2246	55.25	1632
	-384-16	16.0	3.0	75.00	2519	73.25	1905
	-384-24	24.0	4.0	93.00	2791	91.25	2177
24	-386-8	8.0	2.0	62.00	2692	58.00	2080
	-386-16	16.0	3.0	80.00	3021	76.00	2409
	-386-24	24.0	4.0	98.00	3351	94.00	2739
1	2	3	4	5	6	7	8

6505 Fixed Flange Dual Anchor Base



6506 Weld End Dual Anchor Base

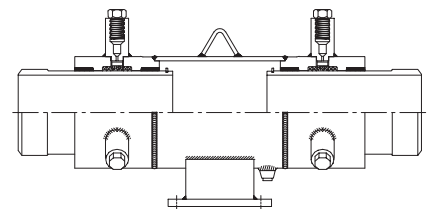

Note:

- (1) Refer to Table 3 for pressure thrust and friction force.
- (2) For Type 6505 and 6506 the travel stated is the total. Travel each side of the anchor base is 1/2 of the tabulated value.
- (3) Refer to Table 4 for the housing outside diameter, packer clearance, drain port size, centerline height for anchor base models, and anchor base details.

Installation Procedure & Maintenance Instructions

Application: Series 6500 Perma-Pax Packed Expansion Joints are designed for applications where the principal motion is axial to the centerline of the expansion joint, and the system includes guides, supports and anchors sufficient to restrain the piping at the service and test conditions. Steam systems must include adequate traps to remove condensate. Liquid systems must include surge compensation.

Operating Conditions: Series 6500 expansion joints are supplied with a tag attached stating the Part Number and Design Pressure. Standard designs are 150 psig and 300 psig, and the test pressures are 225 psig and 450 psig respectively. The design temperature for all standard joints is 500°F. Be certain that the system conditions and test conditions do not exceed the design values.

Movement: The axial travel of the joint is included in the part number as the last digit(s) i.e. P/N 6501-148-4 is designed for 4" axial travel. Consult the purchase specification to confirm the correct part number and location in the system. Refer to Travel Required on Page 5 for the method of calculating travel.

Flow Direction and Orientation: The flow direction can be either direction for Series 6500 expansion joints. Be certain that the free end is attached to the pipe that expands on single joints (6501 & 6502) with an anchor base. The drain port must be at the bottom of the joint for horizontal and vertical installations.

Media & Environment: Series 6500 expansion joints are for properly maintained steam, hot water and chilled water systems. They can be used for other media that are compatible with the materials of construction. Refer to materials of construction on Page 8 for the materials used for standard construction. Be certain that the exterior of the expansion joint is not exposed to corrosive substances such as minerals in ground water and road salt.

Guides, Supports, Anchors: Series 6500 Perma-Pax Packed Expansion Joints are designed for applications where the principal movement is axial to the centerline of the expansion joint, and the system includes guides, supports and anchors. Refer to Applications on Page 4 for system requirements. Refer to Hyspan Series 9500 for pipe alignment guide design information.

Anchor Base: Type 6505 and 6506 dual expansion joints include an anchor base to ensure that the travel on each side

of the base is absorbed on that side. Refer to intermediate anchor forces in the Anchor Forces section on Page 6 for force required. Single expansion joints, types 6501 and 6502, are available with an anchor base designed as a main anchor. Refer to *main* anchor forces in the Anchor Forces section on Page 6 for force required. The anchor base height and base pattern for both configurations is given in Table 4, Page 8. *Caution: the structure attached to the anchor base must be capable of restraining the thrust forces and moments developed by the expansion joint.*

Shipping Restraints: External restraints are installed at the factory to insure installation at the correct length and alignment. They are painted yellow and labeled—*Shipping Bars, Remove after Installation*. Leave these restraints installed until after the installation of the expansion joint is complete—but they must be removed prior to pressure testing. CAUTION: Shipping Bars are not designed to react the pressure thrust of the expansion joint—they must be removed prior to testing. Normally the shipping restraints are installed by welding—remove by cutting and grinding welds flush.

Standard expansion joints are factory set for the travel tabulated in this catalog. The principal travel is axial compression (pipe expansion) with allowance for extension if the pipe temperature is reduced below the installation temperature. Refer to the purchase specifications for joints ordered with special settings. The Installation and Maintenance Instructions included with the joint include instructions for field setting if the pipe temperature is substantially different from 70°F.

Post Installation Inspection

1. Inspect the expansion joint for damage.
2. Are the Shipping Restraints removed?
3. Is the joint free to move and is the pipe supported and guided to ensure that the pipe motion is axial to the expansion joint?
4. Is the expansion joint installed at the correct location and are the anchors, guides and supports installed in accordance with the system design?
5. Are the guides and supports free to allow the movement of the expansion joint?
6. Is the supporting structure for the anchor adequate to react the forces and moments?

Installation Preset

Series 6500 expansion joints can be ordered from the factory preset; however, if it is necessary to change the travel during installation, the shipping bars must be removed and the length adjusted. Table 9 is a tabulation of the thermal expansion or contraction for various pipe run lengths corresponding to temperature differences from 70°F. For example, if the expansion joint is used as a replacement in a system that has not cooled down, and the pipe temperature is 170°F over a 200 foot run, the joint must be compressed 1.53". Refer to Table 3 for the friction force required to compress or extend the joint. Series 6500 expansion joints can be ordered with factory installed threaded adjusting rods for field presetting.

Maintenance

The packing system incorporated into the Series 6500 expansion joints provides combined sealing and lubrication. Packing can be added under full line pressure; however, this is only necessary if a leak occurs, and only enough packing should be added to stop the leak.

1. Standard Injectors: Remove the Plunger nearest the leak and add one packing plug. Inject the packing by resetting the Plunger. Continue this process by adding packing to the remaining Injectors until the leak stops.

Table 9 Installation Preset (SteelPipe)

Temperature Difference	Distance Between Anchors—Feet					
	50	100	150	200	250	300
20	0.08	0.15	0.23	0.31	0.38	0.46
30	0.11	0.23	0.34	0.46	0.57	0.69
40	0.15	0.31	0.46	0.61	0.76	0.92
50	0.19	0.68	0.57	0.76	0.95	1.15
60	0.23	0.46	0.69	0.92	1.15	1.37
70	0.27	0.53	0.80	1.07	1.34	1.60
80	0.31	0.61	0.92	1.22	1.53	1.83
90	0.34	0.69	1.03	1.37	1.72	2.06
100	0.38	0.76	1.15	1.53	1.91	2.29
110	0.42	0.84	1.26	1.68	2.10	2.52
120	0.46	0.92	1.37	1.83	2.29	2.75
140	0.53	1.07	1.60	2.14	2.67	3.20
160	0.61	1.22	1.83	2.44	3.05	3.66
180	0.69	1.37	2.06	2.75	3.43	4.12
200	0.76	1.53	2.29	3.05	3.82	4.57
1	2	3	4	5	6	7

2. Injectors with Safety Valves: As an optional feature a 1/4 turn valve can be incorporated into the Injector. If the valve is installed it should be turned 90° (off) prior to removing the Plunger. Insert the packing and start the Plunger. Open the valve and inject the packing. Follow the procedure from Paragraph 1.

Five (5) Year Limited Warranty

This warranty is given by HYSpan PRECISION PRODUCTS, INC. (HYSpan) for the benefit of the first purchasers for use of its Series 6500 Packed Expansion Joints manufactured by HYSpan to standard catalog construction. The product is warranted to be free from defects in material and workmanship, and to be leak-free for a period of five (5) years from the date of shipment by HYSpan in accordance with the following conditions:

1. The design pressure and temperature are not exceeded –including surge and upset conditions.
2. The installation conforms to HYSpan installation instructions and approved practice for anchoring, supporting and guiding, and generally accepted good piping practice.
3. Substances in contact with all internal and external surfaces must be compatible with the materials of construction, including all contaminants.
4. The warranty shall be limited to the replacement by HYSpan of the same model Series 6500 expansion joint, and payment for transportation by the least expensive method. Labor, material and other costs related to the failure or replacement of the expansion joint are not included. HYSpan shall not be liable for damage or delay suffered by the purchaser regardless of whether such damages are general, special or consequential in nature, whether caused by defective material or workmanship, or whether caused by HYSpan's negligence regardless of the degree.
5. HYSpan warrants satisfactory leak-free performance. If leakage occurs through the packing and cannot be prevented by the addition of packing by the user in accordance with the field packing installation instructions, HYSpan will repair or replace the expansion joint within the terms of this warranty.
6. This warranty is expressed in lieu of all other warranties, expressed or implied, including the warranty of merchantability, the implied warranty of fitness for a particular purpose, and all other obligations or liabilities on the part of HYSpan, and it neither assumes nor authorizes any other persons to assume for HYSpan any other liabilities in connection with the sale of the products.
7. The warranty is limited to installations in the United States, Puerto Rico and Canada.

The purchaser shall advise the HYSpan factory of any warranty claim including the nature of the failure and the serial number of the expansion joint (permanently located adjacent to the lifting lug). HYSpan shall provide return goods authorization and shipping directions to return the failed joint to the factory. A mutually agreeable delivery schedule and method of shipping the replacement shall be established. The purchaser shall furnish a confirming purchase order and is obligated to the current replacement cost of the joint and shipping expense. Upon receipt of the failed product, the cause of failure shall be determined by the factory at no expense to the purchaser. A credit shall be issued by the factory for the replacement cost and least expensive shipping for valid warranty claims. In the event of a dispute, HYSpan shall furnish the failed product to the purchaser or their representative for failure analysis.



Hyspan®

Hyspan Precision Products, Inc.
1685 Brandywine Avenue
Chula Vista, CA 91911

Tel: (619) 421-1355
Fax: (619) 421-1702
www.hyspan.com